

# Magnetics Designer

**Magnetics Designer** provides a fast and simple, yet powerful way to design all types of transformers and inductors, a key part of many electronic systems and power supplies. Virtually any single phase, layer or sector wound, inductor or transformer, from 10Hz to over 5MHz, can be designed and analyzed. All variations from small (planar) to large (power pole) are supported.

**Magnetics Designer** produces a complete transformer or inductor structure based upon your electrical specifications. A database with thousands of cores and a wide variety of materials and wire are included to cover all your design needs. You can add your own cores, wire, and material information using a supplied Excel® spreadsheet.

**Magnetics Designer** uses proprietary algorithms to select the appropriate core, number of turns, and wire sizes to minimize the total power dissipation for a given temperature rise in the smallest possible core. The program predicts magnetizing and leakage inductance, interwinding capacitance, peak flux density, DC and AC winding resistance, copper loss (both AC and DC), core loss, weight, temperature rise, window fill percentage and more.

Magnetics Designer is packed with valuable features. Key examples include the ability to handle sector winding configurations and a bobbin tab that depicts the winding structure. Powerful field solution algorithms produce magnetic field maps that describe core flux behavior. The field solutions also provide accurate calculation of the AC resistance.

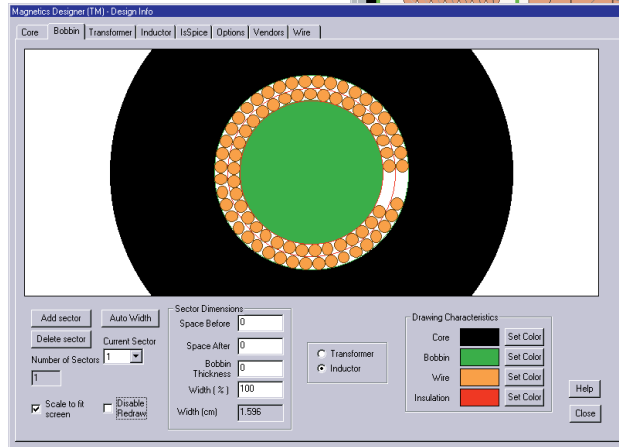
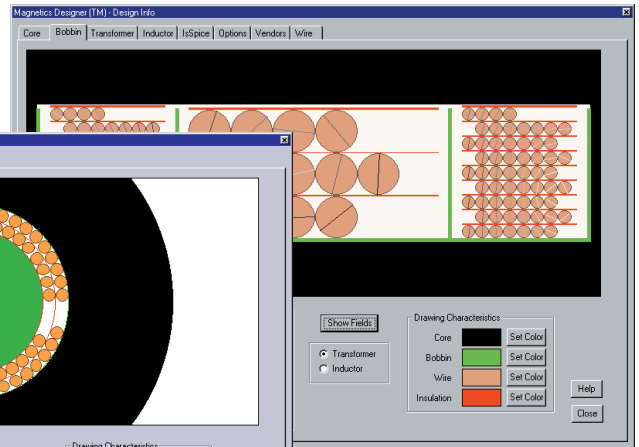

## Key Features:

- Analyzes, designs and optimizes transformers and inductors from electrical specifications -- low to high freq. (>5MHz).
- Analyzes your changes and immediately shows the calculated results each time a parameter is altered.
- Allows change to more than 20 design parameters such as allowed temperature rise, allowed window fill, number of turns, wire gauge and type, bobbin margins, number of parallel strands, gap length, layer insulation thickness, wrapper thickness and end margin lengths. Auto flags any design constraints that are violated.
- Uses sophisticated algorithms to calculate logical manipulations of turns, wire size, number of strands and core geometries to meet electrical requirements, temperature rise and window fill constraints.
- Contains a database of cores from vendors such as ACME, TDK, Magnetics, Philips, Thomson, Micrometals, Siemens, Kaschke, Vac and Fair-Rite. Use formvar, square or double square magnet wire, Litz wire, PCB traces or foil, plus silver or aluminum compositions.
- Enables split, move and interleave windings, plus you can define your own sector dimensions.
- SMPS wizard eases setup of Forward, Push-Pull, Bridge, and Flyback designs.
- Handles applications like 60Hz single-phase line transformers, high frequency switching regulator transformers, AC/output chokes, flyback and forward converter transformers, planar magnetics and more.
- Outputs a winding sheet report for manufacturing, and a complete performance report providing all operating and functional characteristics of the designed magnetic device. Can export bobbin winding structure to a DXF file or SPICE model for further testing.

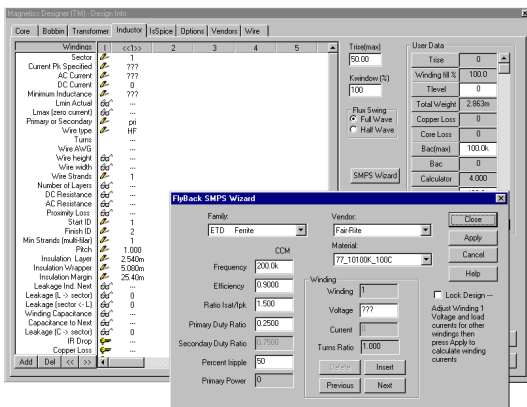

SMPS Wizards help to automate design.

# Magnetics Designer

**Magnetics Designer** has a number of unique features that set it apart from all programs, past and present, that have attempted to tackle transformer and inductor design. The software includes a level of sophistication, ease of use, and power that no traditional techniques can match.

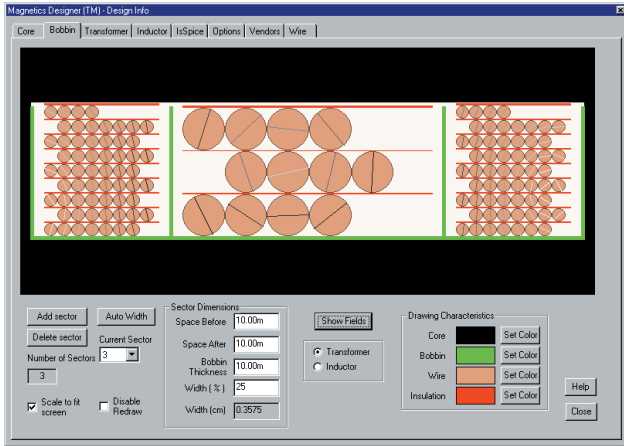

The Core Selection Screen provides thousands of cores to choose from. You can also add your own "exotic" cores, materials, geometries, and wire information. A database of core manufacturers, core distributors, wire distributors, and transformer manufacturers is included.

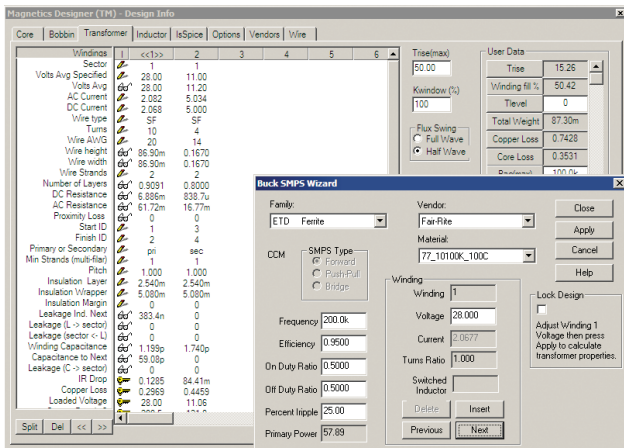

Magnetics Designer's powerful algorithms perform thousands of optimizations allowing you to trade off over 20 different design parameters. Switch Mode Power Supply Wizards are available for transformer coupled Flyback designs and Buck Regulators (shown above). Simply enter the power supply specification and Magnetics Designer computes the spreadsheet entries.

Magnetics Designer can be easily customized. The program exposes all key design variables, and enables you to create your own mathematical equations. This feature furnishes unparalleled flexibility in deriving your own performance merits and optimization criteria.

## Unique Features Set Magnetics Designer Apart

**Magnetics Designer** produces a Berkeley SPICE model of your transformer or inductor design as shown in the SPICE Model Screen (below). The model includes first and second order effects such as AC/DC resistance, frequency dependent losses, leakage inductance and interwinding capacitance. A sophisticated saturable-core SPICE model is also provided. EDIF and Intusoft (SpiceNet) schematic symbols are produced so that you can immediately make use of your design in a simulation.

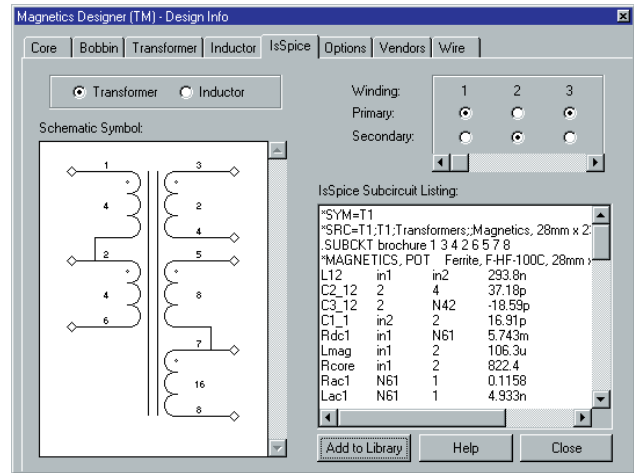

Magnetics Designer produces a detailed "winding sheet" that describes your magnetic device and how it should be constructed. You can even e-mail your design reports directly to a manufacturer.

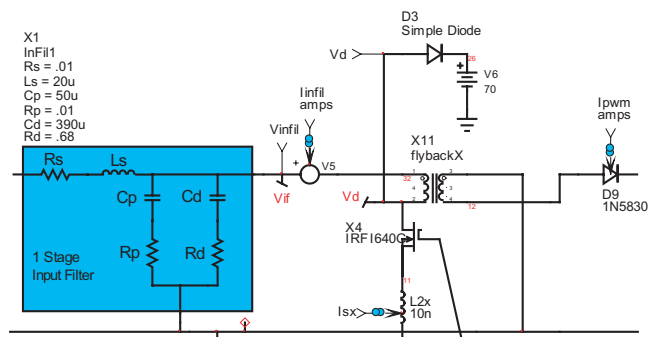

Intusoft's ICAP/4Windows software includes several pre-designed power supply templates that accept SPICE models generated by Magnetics Designer for cycle by cycle switching simulations. Many templates have been added such as Flyback (shown above), Forward and Push-Pull topologies.

Stop designing transformers and inductors using tedious hand calculations! With the features and power of **Magnetics Designer** you can create designs faster and dramatically improve productivity.

**Download A FREE Demo Kit!**  
[www.intusoft.com](http://www.intusoft.com)